

# Jinbo Marine

Marine & Offshore Equipment Datasheet

PRODUCT DATASHEET

## MARINE KITCHEN GALLEY

# AE-30N Marine Multi-Purpose Machine

AE-30N Marine Multi-Purpose Machine 1. The planetary movement of the agitator, so that the food can be fully mixed 2. It adopts mechanical speed change, has multi-level speed, and is equipped with three types of a...

ISO9001 Supplier

Class Certificate

Export Supply



### Key Highlights

Category	Marine Kitchen Galley
Standard	EN
Material	SS
Weight / Size	The base form is suitable for installation and fixing on ships AE-30N Ma...
Certificate	ABS, LR, BV, DNVGL, NK, KR, IRS, RMRS, CCS

We can supply according to your requirement, drawings, class certificate needs, and delivery schedule.



Technical Specifications			
<b>Category</b>	Marine Kitchen Galley	<b>Model / SKU</b>	AE-30N-Marine-Multi-Purpose-Machine
<b>Standard</b>	EN	<b>Material</b>	SS
<b>Weight / Size</b>	The base form is suitable for installation and fixing on ships AE-30N Marine Multi-Purpose Machine Drawing AE-30N Marine Multi-Purpose Machine Parameters Model K7 AE-20N AE-30N AE-40N AE-60N Volume(L) 7 20 30 40 60 Voltage 220v-1PH-50Hz 220V-1PH-50Hz 380/415V-3PH-50Hz 440/480V/3PH-60Hz 380/415V-3PH-50Hz 440/480V/3PH-60Hz Power(kw) 0.37 1.1 1 1.5 3 Size(mm) 460X290X470 560X600X780 625X610X945 570X615X1130 700X1050X1445 Weight(kg) 29 100 180 180 410	<b>Certificate</b>	ABS, LR, BV, DNVGL, NK, KR, IRS, RMRS, CCS
<b>Warranty</b>	12 Months unless specified otherwise	<b>Origin</b>	China

**CONTENTS**

- AE-30N Marine Multi-Purpose Machine
- AE-30N Marine Multi-Purpose Machine Drawing
- AE-30N Marine Multi-Purpose Machine Parameters

## AE-30N Marine Multi-Purpose Machine

1. The planetary movement of the agitator, so that the food can be fully mixed
2. It adopts mechanical speed change, has multi-level speed, and is equipped with three types of agitators: snake-shaped, beat-shaped, and flower-bud
3. Stainless steel mixing barrel
4. A safety net cover is set on the mixing barrel
5. The base form is suitable for installation and fixing on ships

## AE-30N Marine Multi-Purpose Machine Drawing

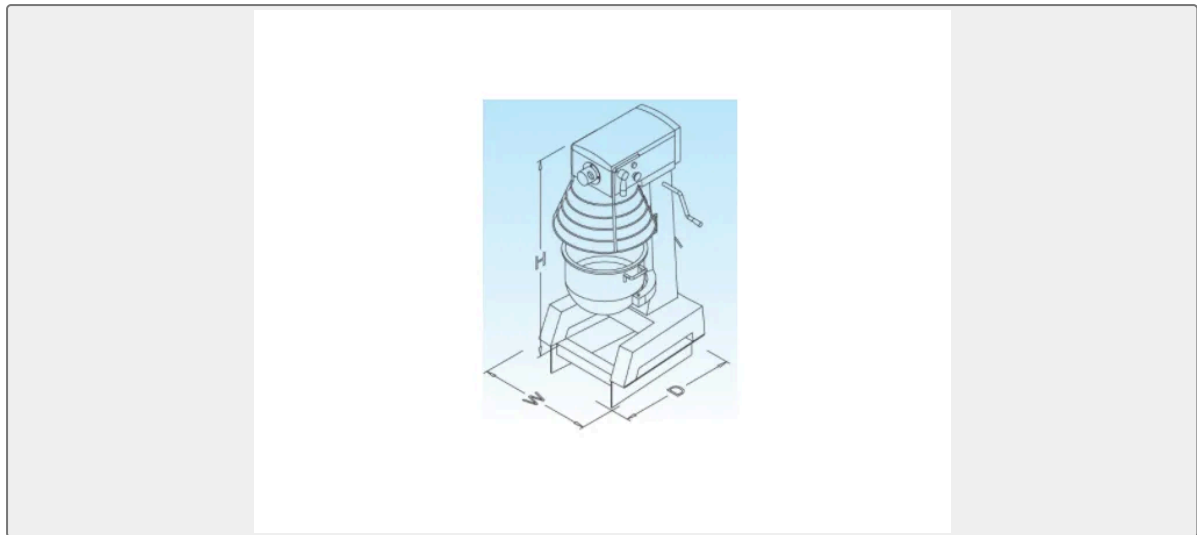

## AE-30N Marine Multi-Purpose Machine Parameters

Model	K7	AE-20N	AE-30N	AE-40N	AE-60N
Volume(L)	7	20	30	40	60
Voltage	220v-1PH-50Hz	220V-1PH-50Hz 380/415V-3PH-50Hz 440/480V/3PH-60Hz		380/415V-3PH-50Hz	440/480V/3PH-60Hz
Power(kw)	0.37	1.1	1	1.5	3
Size(mm)	460X290X470	560X600X780	625X610X945	570X615X1130	700X1050X1445
Weight(kg)	29	100	180	180	410