

Jinbo Marine

Marine & Offshore Equipment Datasheet

PRODUCT DATASHEET

MARINE KITCHEN GALLEY

DCZ-24S Marine Electromagnetic Oven

DCZ-24S Marine Electromagnetic Oven 1. All stainless steel structure 2. Imported microcrystalline panel, long service life 3. Sealed movement with imported electrical components 4. Equipped with five-speed power...

ISO9001 Supplier

Class Certificate

Export Supply



Key Highlights

Category	Marine Kitchen Galley
Standard	EN
Material	SS
Weight / Size	Equipped with stainless steel adjustable feet for easy installation on b...
Certificate	ABS, LR, BV, DNVGL, NK, KR, IRS, RMRS, CCS

We can supply according to your requirement, drawings, class certificate needs, and delivery schedule.

Technical Specifications			
Category	Marine Kitchen Galley	Model / SKU	DCZ-24S-Marine-Electromagnetic-Oven
Standard	EN	Material	SS
Weight / Size	Equipped with stainless steel adjustable feet for easy installation on board DCZ-24S Marine Electromagnetic Oven Drawing DCZ-24S Marine Electromagnetic Oven Parameters Model DCZ-08 DCZ-10S ACZ-16S DCZ-24S Voltage 380/415V-3PH-50Hz 440/480v 3ph-60Hz Power(kw) 5/8 2X5 2X8 2X12 Size(mm) 800X800X850 1400X800X850 1400X850X850 1400X850X850 Weight(kg) 75 100 110 120 Remark Dimensions can be customized	Certificate	ABS, LR, BV, DNVGL, NK, KR, IRS, RMRS, CCS
Warranty	12 Months unless specified otherwise	Origin	China

CONTENTS

- DCZ-24S Marine Electromagnetic Oven
- DCZ-24S Marine Electromagnetic Oven Drawing
- DCZ-24S Marine Electromagnetic Oven Parameters

DCZ-24S Marine Electromagnetic Oven

1. All stainless steel structure
2. Imported microcrystalline panel, long service life
3. Sealed movement with imported electrical components
4. Equipped with five-speed power adjustment switch and multi-function display
5. Equipped with stainless steel adjustable feet for easy installation on board

DCZ-24S Marine Electromagnetic Oven Drawing

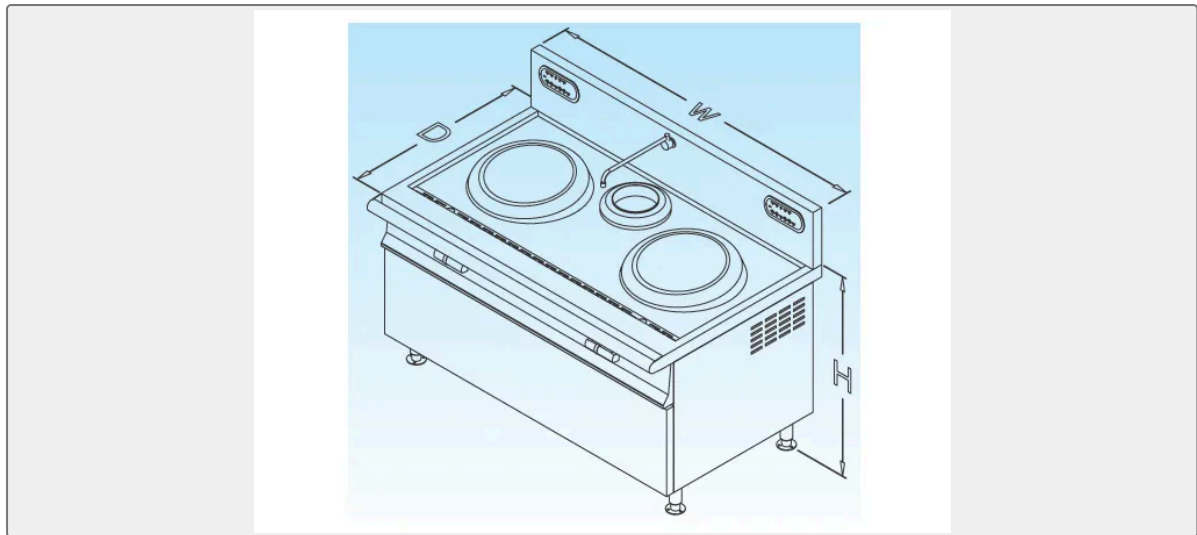

DCZ-24S Marine Electromagnetic Oven Parameters

Model	DCZ-08	DCZ-10S	ACZ-16S	DCZ-24S
Voltage	380/415V-3PH-50Hz 440/480v 3ph-60Hz			
Power(kw)	5/8	2X5	2X8	2X12
Size(mm)	800X800X850	1400X800X850	1400X850X850	1400X850X850
Weight(kg)	75	100	110	120
Remark	Dimensions can be customized			