

Jinbo Marine

Marine & Offshore Equipment Datasheet

PRODUCT DATASHEET

MARINE KITCHEN GALLEY

DCZ-25GS Marine Electromagnetic Oven

ISO9001 Supplier

Class Certificate

Export Supply

DCZ-25GS Marine Electromagnetic Oven 1. All stainless steel structure 2. The pot body is formed by one-time stamping 3. Sealed movement with imported electrical components 4. Equipped with five-speed power adjus...



Key Highlights

Category	Marine Kitchen Galley
Standard	EN
Material	SS
Weight / Size	Equipped with stainless steel adjustable feet for easy installation on b...
Certificate	ABS, LR, BV, DNVGL, NK, KR, IRS, RMRS, CCS

We can supply according to your requirement, drawings, class certificate needs, and delivery schedule.



Technical Specifications			
Category	Marine Kitchen Galley	Model / SKU	DCZ-25GS-Marine-Electromagnetic-Oven
Standard	EN	Material	SS
Weight / Size	Equipped with stainless steel adjustable feet for easy installation on board DCZ-25GS Marine Electromagnetic Oven Drawing DCZ-25GS Marine Electromagnetic Oven Parameters Model DCZ-15GS DCZ-18GS DCZ-25GS Voltage 380/415V-3PH-50Hz 440/480v 3ph-60Hz Power(kw) 15/18 2X18/2X20 2X25/2X28 Size(mm) 1100X1500X850 2000X1150X850 2000X1150X850 Weight(kg) 100 150 160 Remark Dimensions can be customized	Certificate	ABS, LR, BV, DNVGL, NK, KR, IRS, RMRS, CCS
Warranty	12 Months unless specified otherwise	Origin	China

CONTENTS

- DCZ-25GS Marine Electromagnetic Oven
- DCZ-25GS Marine Electromagnetic Oven Drawing
- DCZ-25GS Marine Electromagnetic Oven Parameters

DCZ-25GS Marine Electromagnetic Oven

1. All stainless steel structure
2. The pot body is formed by one-time stamping
3. Sealed movement with imported electrical components
4. Equipped with five-speed power adjustment switch and multi-function display
5. Equipped with stainless steel adjustable feet for easy installation on board

DCZ-25GS Marine Electromagnetic Oven Drawing

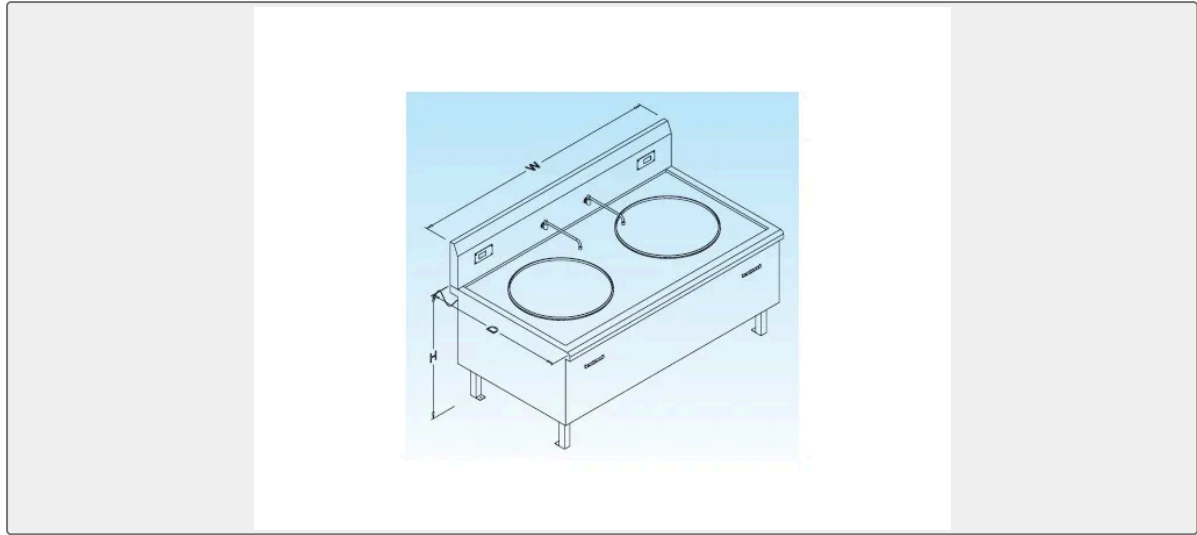

DCZ-25GS Marine Electromagnetic Oven Parameters

Model	DCZ-15GS	DCZ-18GS	DCZ-25GS
Voltage	380/415V-3PH-50Hz 440/480v 3ph-60Hz		
Power(kw)	15/18	2X18/2X20	2X25/2X28
Size(mm)	1100X1500X850	2000X1150X850	2000X1150X850
Weight(kg)	100	150	160
Remark	Dimensions can be customized		