

# Jinbo Marine

Marine & Offshore Equipment Datasheet

PRODUCT DATASHEET

FILTER

## DDL125 Single Drum Strainer

DDL125 Single Drum Strainer&nbsp;1.The single drum strainer may act as strainer(first filter)before pump or bypass strainer after pump.meanwhile,it's applicable for filtering heavy oil and with self-sustaining fun...

ISO9001 Supplier

Class Certificate

Export Supply



### Key Highlights

Category	Filter
Standard	EN
Material	may be achieved in two options,e.g.straightforward connection or attache...
Weight / Size	DDL125 Single Drum Strainer Drawing DDL125 Single Drum Strainer Technica...
Certificate	ABS, LR, BV, DNVGL, NK, KR, IRS, RMRS, CCS

We can supply according to your requirement, drawings, class certificate needs, and delivery schedule.



Technical Specifications				
<b>Category</b>	Filter	<b>Model / SKU</b>	DDL125-Single-Drum-Strainer	
<b>Standard</b>	EN	<b>Material</b>	may be achieved in two options,e.g.straightforward connection or attached in a right-angle.shell of the strainer is made of Q235A, with element designed as stainless steel cage,filtering precision in spec anging from 40 mesh/inch are available upon request.	
<b>Weight / Size</b>	DDL125 Single Drum Strainer Drawing DDL125 Single Drum Strainer Technical Parameters DN Structure size Flange Anchor Weight(kg) L H1 H2 H3 H4 Φ D D1 D2 N DO N-D1 65 250 680 525 452 352 321 185 145 122 4 18 3-Φ24 55 80 340 810 642 562 446 412 200 160 133 8 18 95 100 340 915 725 625 515 412 200 160 133 8 18 108 125 400 925 725 612 445 512 250 210 184 8 18 145 150 400 1065 865 740 520 512 285 240 212 8 22 168 200 448 110 880 725 475 612 340 295 268 8 22 205 250 448 1340 1120 940 660 612 390 350 320 12 22 250		<b>Certificate</b>	ABS, LR, BV, DNVGL, NK, KR, IRS, RMRS, CCS
<b>Warranty</b>	12 Months unless specified otherwise	<b>Origin</b>	China	

<b>CONTENTS</b>	<ul style="list-style-type: none"> <li>■ DDL125 Single Drum Strainer</li> <li>■ DDL125 Single Drum Strainer Drawing</li> <li>■ DDL125 Single Drum Strainer Technical Parameters</li> </ul>
-----------------	--

## DDL125 Single Drum Strainer

- 1.The single drum strainer may act as strainer(first filter)before pump or bypass strainer after pump.meanwhile,it's applicable for filtering heavy oil and with self-sustaining function of heating.
2. Connection of single drum strainer: may be achieved in two options,e.g.straightforward connection or attached in a right-angle.shell of the strainer is made of Q235A, with element designed as stainless steel cage,filtering precision in spec anging from 40 mesh/inch are available upon request.
3. The product performs quite effectively in filtering while ensuring efficient pass-through of various oils,which is easy to operate and convenient for maintenance.
4. The single drum strainer is widely applied for filtering lubricant,fuel and heavy oils in oil pipelines attached to various models of diesel generators both onboard and on land,it's also applied for filtering process of petroleum,power,chemical and sewage treatment facilities.

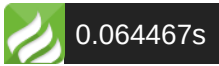

# DDL125 Single Drum Strainer Drawing

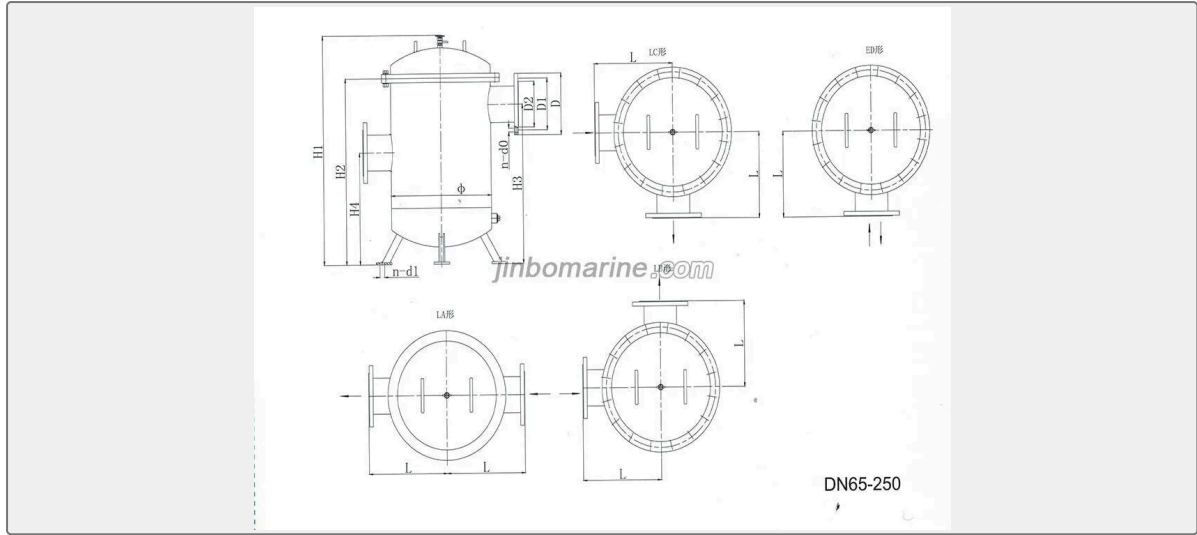

## DDL125 Single Drum Strainer Technical Parameters

DN	Structure size						Flange					Anchor	Weight (kg)
	L	H1	H2	H3	H4	Φ	D	D1	D2	N	DO	N-D1	
65	250	680	525	452	352	321	185	145	122	4	18	3-Φ24	55
80	340	810	642	562	446	412	200	160	133	8	18	95	
100	340	915	725	625	515	412	200	160	133	8	18	108	
125	400	925	725	612	445	512	250	210	184	8	18	145	
150	400	1065	865	740	520	512	285	240	212	8	22	168	
200	448	1110	880	725	475	612	340	295	268	8	22	205	
250	448	1340	1120	940	660	612	390	350	320	12	22	250	