

Jinbo Marine

Marine & Offshore Equipment Datasheet

PRODUCT DATASHEET

MARINE KITCHEN GALLEY

DQG-12 Marine Tilting Electric Frying Pan

ISO9001 Supplier

Class Certificate

Export Supply

DQG-12 Marine Tilting Electric Frying Pan 1. All stainless steel structure 2. The pot bottom rounded corner design, easy to clean 3. Handwheel or electric drive tilting pan can be selected as required 4. The han...



Key Highlights

Category	Marine Kitchen Galley
Standard	EN
Material	SS
Weight / Size	Equipped with stainless steel adjustable sole for easy installation on b...
Certificate	ABS, LR, BV, DNVGL, NK, KR, IRS, RMRS, CCS

We can supply according to your requirement, drawings, class certificate needs, and delivery schedule.



Technical Specifications			
Category	Marine Kitchen Galley	Model / SKU	DQG-12-Marine-Tilting-Electric-Frying-Pan
Standard	EN	Material	SS
Weight / Size	Equipped with stainless steel adjustable sole for easy installation on board DQG-12 Marine Tilting Electric Frying Pan Drawing DQG-12 Marine Tilting Electric Frying Pan Parameters Model DQG-9 DQG-10 DQG-12 DQG-14 DQG-10D (electric) DQG-12 (electric) Volume(L) 40 60 80 100 60 80 Voltage 380/415V-3PH-50Hz 440/480v 3ph-60Hz Power(kw) 9 10.8 12.6 14.8 10.8 12.6 Size(mm) 700X700X850 850X700X850 1000X850X850 850X700X850 850x700x50 1000x700x850 Weight(kg) 120 140 150 160 140 150	Certificate	ABS, LR, BV, DNVGL, NK, KR, IRS, RMRS, CCS
Warranty	12 Months unless specified otherwise	Origin	China

CONTENTS	■ DQG-12 Marine Tilting Electric Frying Pan	■ DQG-12 Marine Tilting Electric Frying Pan Drawing
	■ DQG-12 Marine Tilting Electric Frying Pan Parameters	

DQG-12 Marine Tilting Electric Frying Pan

1. All stainless steel structure
2. The pot bottom rounded corner design, easy to clean
3. Handwheel or electric drive tilting pan can be selected as required
4. The hand wheel is driven by a turbine rod to drive the tilting pan
5. Electric type adopts imported lifting system to drive the tilting pot
6. With pot body not in place protection
7. The temperature at the bottom of the pot is controlled by a thermostat
8. Equipped with stainless steel adjustable sole for easy installation on board

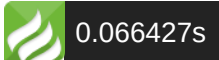

DQG-12 Marine Tilting Electric Frying Pan Drawing

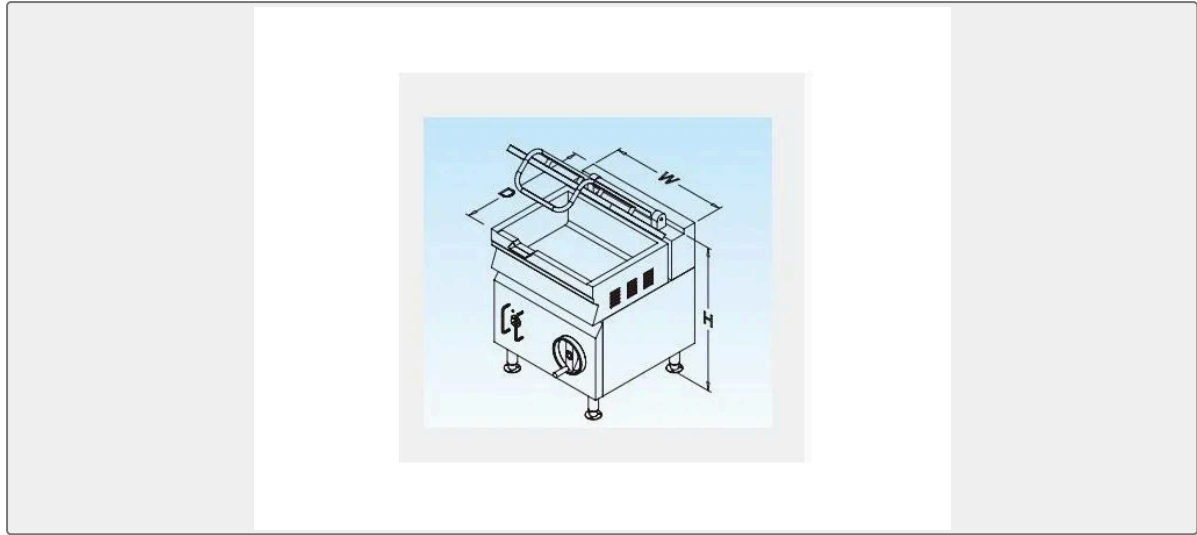

DQG-12 Marine Tilting Electric Frying Pan Parameters

Model	DQG-9	DQG-10	DQG-12	DQG-14	DQG-10D (electric)	DQG-12 (electric)
Volume(L)	40	60	80	100	60	80
Voltage	380/415V-3PH-50Hz 440/480v 3ph-60Hz					
Power(kw)	9	10.8	12.6	14.8	10.8	12.6
Size(mm)	700X700X850	850X700X850	1000X850X850	850X700X850	850x700x50	1000x700x850
Weight(kg)	120	140	150	160	140	150