

Jinbo Marine

Marine & Offshore Equipment Datasheet

PRODUCT DATASHEET

FILTER

XZL350 Model Inspiration Strainer Filter

ISO9001 Supplier

Class Certificate

Export Supply

XZL350 Model Inspiration Strainer Filter This strainer is applicable for oil pipelines of diesel generator and other equipment for filtering lubricant, fuel oil and heavy oil, operation pressure of which is recomme...

Key Highlights

Category	Filter
Standard	EN
Weight / Size	XZL350 Model Inspiration Strainer Filter Drawing XZL350 Model Inspiratio...
Certificate	ABS, LR, BV, DNVGL, NK, KR, IRS, RMRS, CCS

We can supply according to your requirement, drawings, class certificate needs, and delivery schedule.



Technical Specifications			
Category	Filter	Model / SKU	XZL350-Model-Inspiration-Strainer-Filter
Standard	EN	Weight / Size	XZL350 Model Inspiration Strainer Filter Drawing XZL350 Model Inspiration Strainer Filter Technical Parameters DN Structure size Flange Anchor L H1 H2 H3 H4 Φ D D1 D2 n n n-d1 100 240 630 465 375 289 312 220 180 158 8 8 3- Φ 22 125 250 680 515 422 339 250 210 184 8 22 150 340 810 642 527 357 412 285 240 212 200 340 915 740 595 375 340 295 268 250 400 1005 820 635 365 512 395 350 320 300 400 1145 965 750 430 445 400 375 16 22 350 448 1255 1045 810 440 612 505 460 430 400 448 1420 1220 950 530 565 515 482
Certificate	ABS, LR, BV, DNVGL, NK, KR, IRS, RMRS, CCS	Warranty	12 Months unless specified otherwise
Origin	China		

CONTENTS	<ul style="list-style-type: none"> ■ XZL350 Model Inspiration Strainer Filter ■ XZL350 Model Inspiration Strainer Filter Technical Parameters 	<ul style="list-style-type: none"> ■ XZL350 Model Inspiration Strainer Filter Drawing
-----------------	---	--

XZL350 Model Inspiration Strainer Filter

This strainer is applicable for oil pipelines of diesel generator and other equipment for filtering lubricant, fuel oil and heavy oil, operation pressure of which is recommended not to exceed 0.8Mpa, working temperature I $t \leq 85^{\circ}\text{C}$ II $t \leq 135^{\circ}\text{C}$ $\leq 200^{\circ}\text{C}$, with range of filtering precision available for option between 20-200 mesh/inch. It's designed with top inlet and bottom outlet, all filtered substances are intercepted inside the mesh cage, which is easy to clear and clear. Magnet maybe equipped for adsorption of ferromagnet upon request.

XZL350 Model Inspiration Strainer Filter Drawing

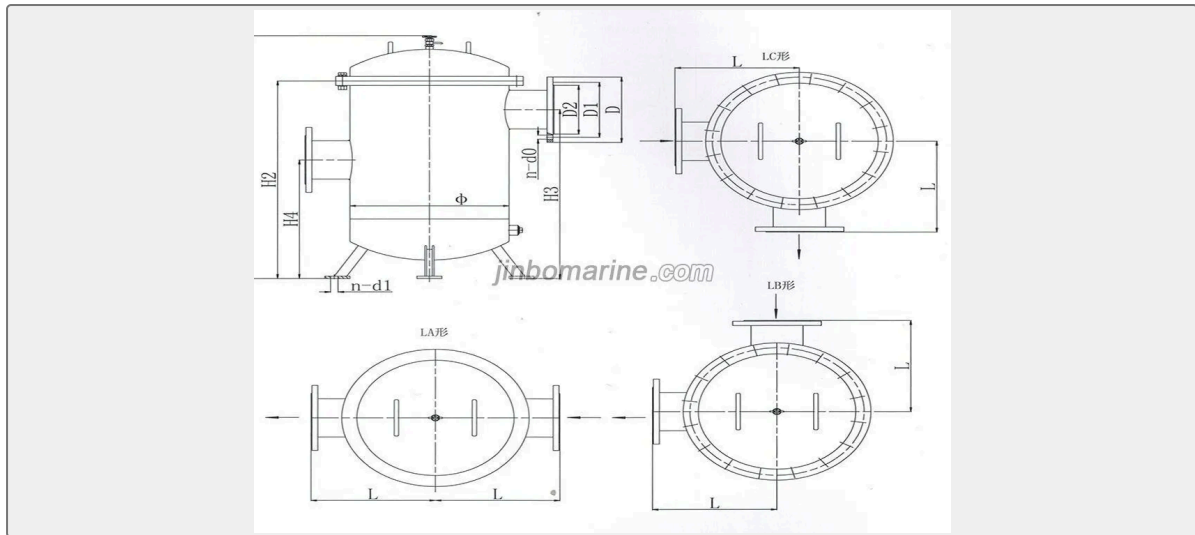

XZL350 Model Inspiration Strainer Filter Technical Parameters

DN	Structure size						Flange					Anchor
	L	H1	H2	H3	H4	Φ	D	D1	D2	n	n	n-d1
100	240	630	465	375	289	312	220	180	158	8	8	3-Φ22
125	250	680	515	422	339		250	210	184	8	22	
150	340	810	642	527	357	412	285	240	212			
200	340	915	740	595	375		340	295	268			
250	400	1005	820	635	365	512	395	350	320			
300	400	1145	965	750	430		445	400	375	16	22	
350	448	1255	1045	810	440	612	505	460	430			
400	448	1420	1220	950	530		565	515	482			